



**Omega Pool  
Installation  
User's Guide**

**WARNING:** Shallow water! Never jump or dive into an above-ground pool; serious bodily injury could occur.

Congratulations on the purchase of your pool!

A few notes prior to assembly. . .

*Before starting to install your new pool, please read through all instructions in the Owner's Manual and check that you have received all parts for your pool. A list of parts can be found on Page 3. Please refer to the pump installation guide for any questions about the pump and filtration system.*

Be sure that you have an area that is smooth, level and 4 feet larger than the pool to assemble your pool. Remove all sticks, rocks, and any sharp objects. Remove and cap off any sprinkler heads, fill voids, depressions, or hollows with dirt or sand. Any areas filled with dirt or sand must be compacted prior to the installation of your pool.

If you are installing your pool on dirt, sand, or grass, we recommend that you place a plastic tarp or foam pad between your pool and the ground.

As portable swimming pools, most localities do not require the homeowner to obtain any permits. However, it is the homeowner's responsibility to meet all applicable safety/health codes and zoning regulations.

**WARNING: NEVER INSTALL YOUR POOL UNDERNEATH HIGH VOLTAGE POWER LINES — SERIOUS INJURY OR DEATH COULD RESULT.**

**WARNING: SHALLOW WATER! NEVER JUMP OR DIVE INTO A SPLASH SUPERPOOL — SERIOUS BODILY INJURY COULD OCCUR!**

# Table of Contents

Congratulations! ..... 1

Round Pool Parts List..... 3

Getting Started ..... 4

Installing Circulation System ..... 10

Filling and Starting Your Pool ..... 11

Vacuuming Your Pool ..... 12

Cleaning Filter and Pump Basket..... 13

Winterizing Your Pool..... 14

**Never leave children or inexperienced swimmers alone  
in any pool.**

**WARNING: SHALLOW WATER!**

**NEVER JUMP OR DIVE INTO AN ABOVE-GROUND  
POOL!**

Round Pool Parts List

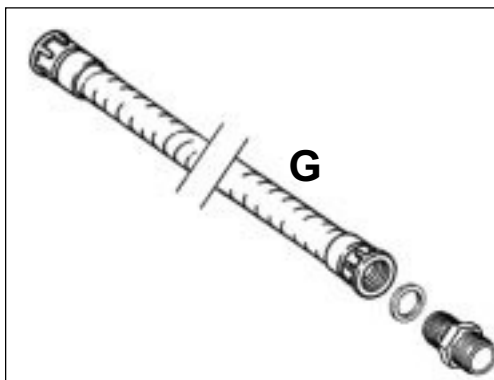
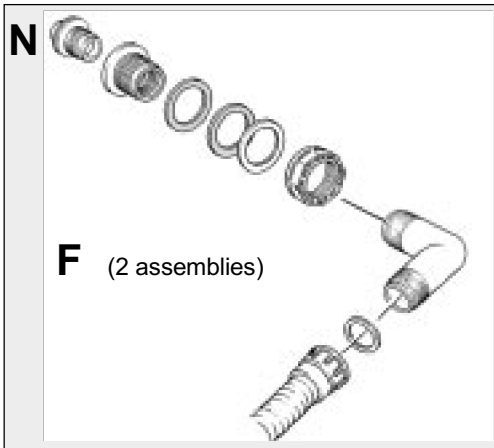
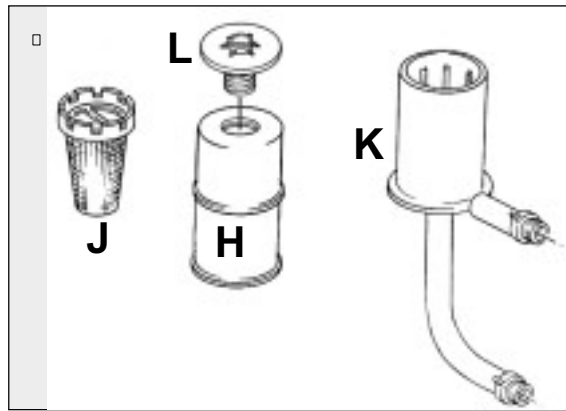
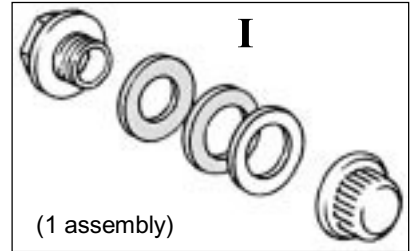
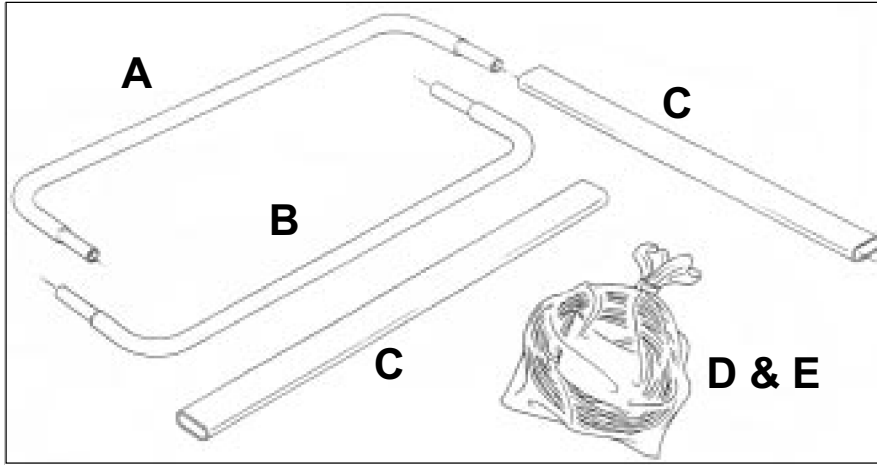

- A. Galvanized Top Structure Tube
- B. White Powder Coated Bottom Structure Tube
- C. Upright Structure Tube
- D. Clear Elastic PVC Hose
- E. Connecting Pins
- F. Wall Fittings
- G. Hose w/Threaded Nipple/Gasket
- H. Floating Skimmer Weir
- I. Skimmer Hold Down
- J. Skimmer Basket
- K. Skimmer
- L. Vacuum Adapter Plate
- M. Ball Valve
- N. Eyeball Fitting

# Round Pool Assembly Instructions

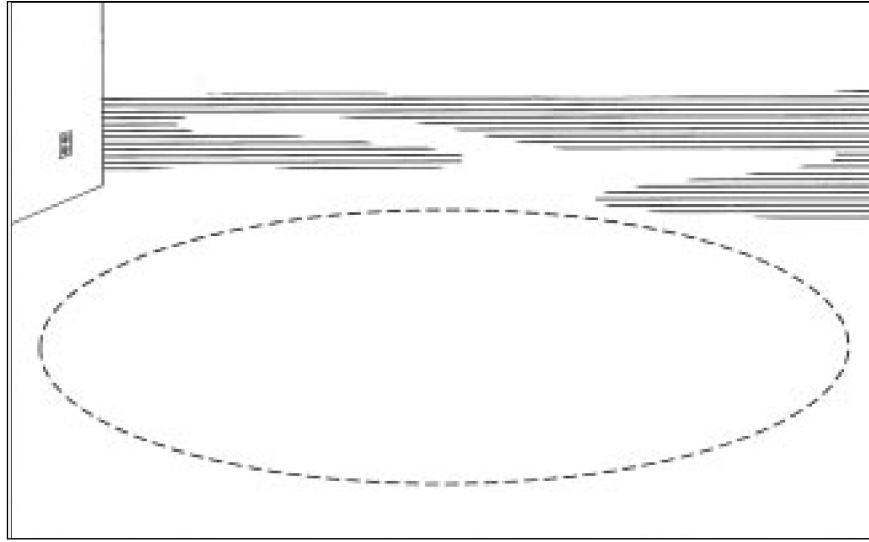

1. Prepare the ground by picking up all sticks, rocks, and other sharp objects that may damage the pool. Add two feet to the pool's size when clearing an area (Example: Clear a 22' foot area for a 20' foot pool.) Make sure the area is level.

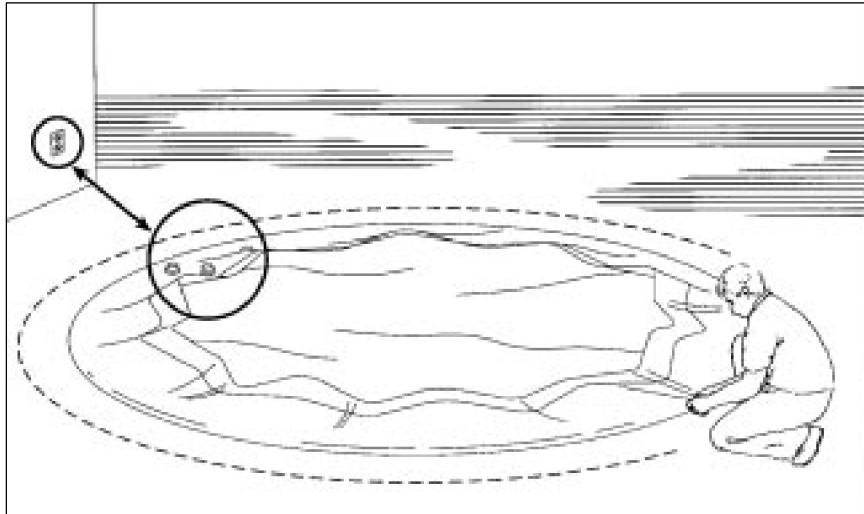

2. Spread the pool out over the cleared surface. Line up holes in the pool (where Skimmer attaches, two holes) with the electrical outlet that is planned for the pump and filter.

**WARNING: Shallow water! Never jump or dive into an above-ground pool; serious bodily injury could occur.**

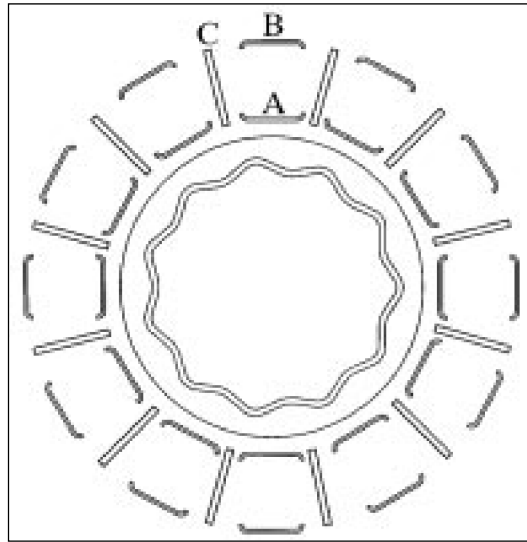

3. Place the structure around the outside of the pool, making sure the top and bottom Structure Tubes lay together. The Galvanized Tubes are the top (A) and the White Tubes are the bottom (B). When laying out the structure, place one Upright Structure Tube (C) with every set of top and bottom Structure Tubes (A & B) .

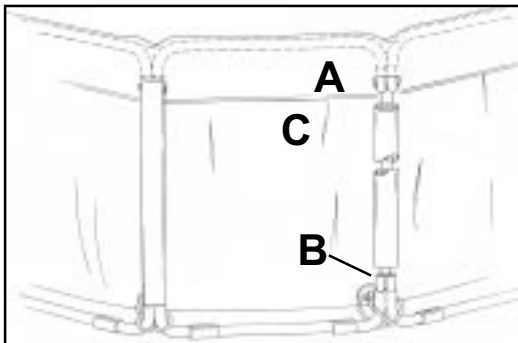

4A

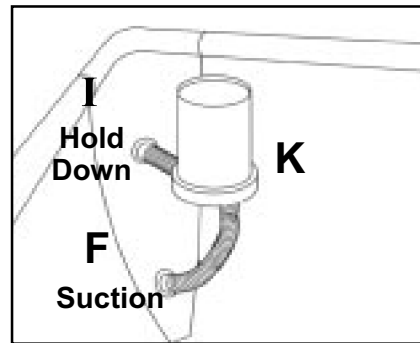

4B

Slide the top tube (A) through the openings in the white part of the pool. Insert top tube (A) into Upright Structure Tube (C). Insert bottom Structure Tube (B) into Upright Structure Tube (C), as shown in figure 4A. For ease in assembly, have one person stand inside the pool and one person outside the pool. Continue assembly around the entire pool. Before exiting the pool, insert wall fittings and skimmer.

**WARNING: Strong suction! Never lay on or insert body parts into skimmer while pump is operating.**

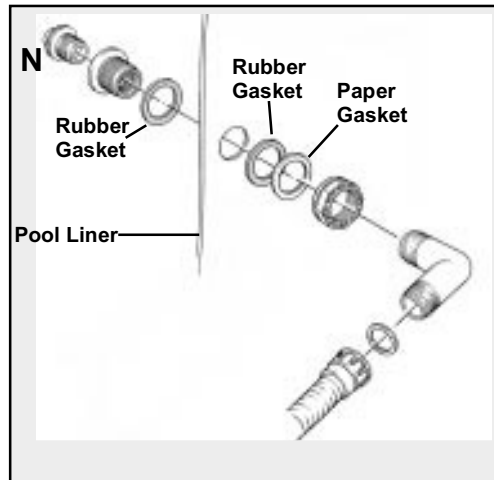

5A

5. Attach the Return Wall Fitting on the pool (See Figure 5A). Put one Rubber Gasket on the inside of the pool and a Rubber Gasket and Paper Gasket on the outside. Screw the return Eyeball Fitting (N) into it on the inside of the pool. This is where the water will return to the pool from the filtration system. On the outside of the return wall fitting you will insert the 90 degree elbow. Note that there is a “Hose Side” on end of the elbow. Be sure that is not the end that goes into the wall fitting. Use Teflon tape on the threads that screw into the wall fitting to achieve a proper seal. Attach the Skimmer Suction Wall Fitting in bottom hole where the skimmer suction hose will be attached (F in image 4B). Use the same order of gaskets as shown in image 5A. The nut portion of the fitting will be on the outside of the pool. Insert the Skimmer Hold Down Wall Fitting into the top hole where the skimmer is located (I in image 4B). The Skimmer Hold Down Wall fitting is smaller than the other two wall fittings and has a cap that has the Splash logo on the outside.

#### 1. Skimmer Installation using the Splash QC Fittings —

a) Take the short gray hose in your Box4B and twist it onto the barb on the side of the skimmer housing with the black threaded piece away from the housing. It will screw into the Skimmer Hold Down Wall Fitting later. You should have a blue skimmer suction hose in your Box4B with the female QC fitting already installed in one end. Attach the other end to the bottom of the skimmer housing with a twisting motion. *Tip: The blue hose will twist easier in one direction. If it is difficult to turn, try twisting it the other way. Soapy water may also be used for this.* The curvature of the new skimmer hose should align with the gray skimmer hose as shown to the right. If you have aligned it properly, the blue tabs on the female QC fitting will be in the 12 o'clock and 6 o'clock positions when the skimmer is attached and in its proper skimming position.

b) Now you will need to add the male QC adapter. Screw the male adapter into the skimmer suction wall fitting (H) on the inside of your pool. Align the male adapter as close as possible with the two blue lines in the slots at the 9 o'clock and 3 o'clock positions (image 1). The blue line on the nut portion of the adapter should now be in the 12 o'clock position (image 1). If necessary, to get the blue lines in the correct positions, SLIGHTLY loosen the octagonal nut located on the exterior of your skimmer suction wall fitting (image 2). You can now turn the whole wall fitting to get the adapter in the correct orientation. Once you have done that, be sure and retighten the nut on the outside of the wall fitting.



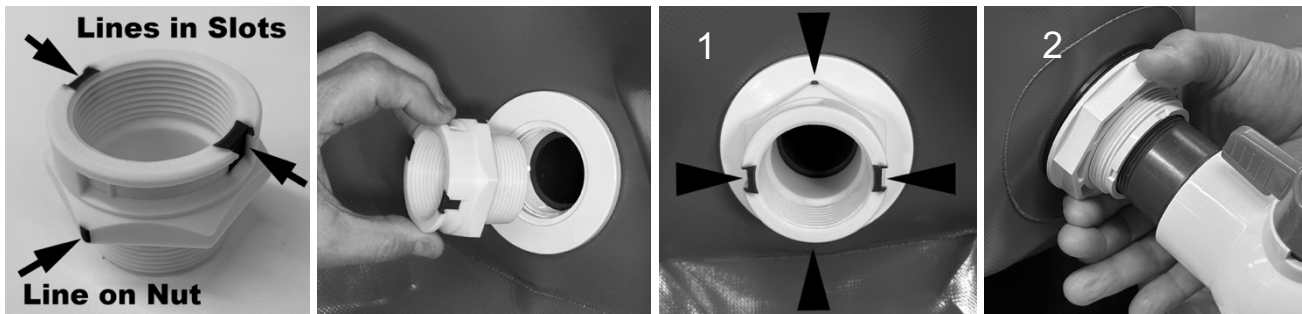

- c) For correct orientation of the skimmer when finished, it needs to turn clockwise on the wall fitting with the male adapter. To make sure you start in the right place, the skimmer will lean to the left to start. See image 3 for your starting point. Align the blue tabs on the exterior of the female fitting with the blue lines in the slots of the male adapter (image 4) and slide the fitting down over the adapter. The nubs inside the female QC fitting should fit into the slot openings on the male QC adapter.

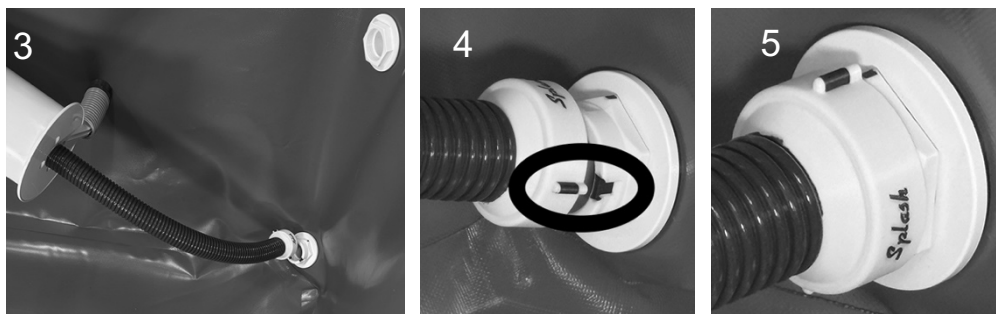

- d) Rotate the entire skimmer clockwise to lock the two parts together. Rotate until you feel it “click” into position. You will feel a resistance and then it snaps into a locked position. The tab on the female part and the line on the nut of the wall adapter should both be in the 12 o’clock position (image 5). Test the connection by twisting the skimmer slightly back in the opposite direction. There should be some resistance. If the tabs on the QC fitting don’t rotate back to the beginning position with the skimmer, the connection is good
- e) Screw the gray skimmer hose into the Skimmer Hold Down Wall Fitting (K) and adjust the skimmer housing so that it sits upright in the pool corner.
- f) Place the skimmer basket and floating weir on the housing. Now is when the person inside the pool will want to get out.

## REMOVING AND REATTACHING YOUR SKIMMER WITH THE QUICK-CONNECT FITTING INSTALLED

### Removing the skimmer from outside the pool (winterizing procedure)

- To remove, shut off your filtration system and remove your skimmer basket and weir.
- Unscrew the gray skimmer hose from the hold down (top) wall fitting in your pool.
- Applying steady force, hold your skimmer housing and rotate your skimmer counterclockwise until the QC adapter releases the quick-connect fitting. You will turn the skimmer approximately quarter turn and you should be able to remove your skimmer.

**TIP:** It will help if you place your foot on the ball valve and put some downward pressure on it. This points the wall fitting upwards and makes it easier to remove or install. This is also a great help when trying to insert or remove the winterizing plug using the winterizing tool.

- d) The male QC adapter which stays attached to the wall fitting also has internal threads. If you are winterizing your pool at the end of the season, use the Splash winterizing tool (available on the website) to screw a winterizing plug into the adapter. You should have received winterizing plugs when you purchased your Splash pool. If you need additional plugs they can be found on our parts portion of our site. Since the winterizing plug has an O-ring there is no need to tighten it down as tight as you can. Just get it snug and the O-ring will do its job. If you put it in tight, in the spring when you try to remove it the wall adapter may come out instead of the winterizing plug. Be sure and open the ball valve to allow any trapped water to drain out. Leave the ball valve open while winterizing plug is in place.

**WARNING:** DO NOT START YOUR PUMP AND FILTRATION SYSTEM WITHOUT THE SKIMMER ATTACHED. DOING SO IS A SAFETY HAZARD. A SWIMMER OR AN OBJECT CAN BE CAUGHT BY THE UNRESTRICTED SUCTION.

### Installing the skimmer from outside your pool (opening the pool for spring)

**Tip:** If you are installing the QC fittings with water in the pool, you can use a storage bin, or Tupperware container with a clear transparent bottom as a makeshift aqua scope. Floating the container on the water will maintain a flat surface to view through, preventing ripples and waves from distorting your underwater view. It may be helpful to have someone hold this while you are working on aligning the QC adapters.

- a) Close the ball valve on the outside of the Skimmer Suction Wall Fitting and remove the winterization plug that you put in when you removed the skimmer. This is easiest done using the Splash Winterization Tool if you do not already have one. It can also be done from inside the pool.
- b) For correct orientation of the skimmer when finished, it needs to turn clockwise on the wall fitting with the male adapter. To make sure you start in the right place, if you are outside the pool, the skimmer will lean to the right to begin. If you are inside the pool, it will lean to the left to start. See image 3 for your starting point. Align the blue tabs on the exterior of the female fitting with the blue lines in the slots of the male adapter (image 4) and slide the fitting down over the adapter. The nubs inside the female QC fitting should fit into the slot openings on the male QC adapter.

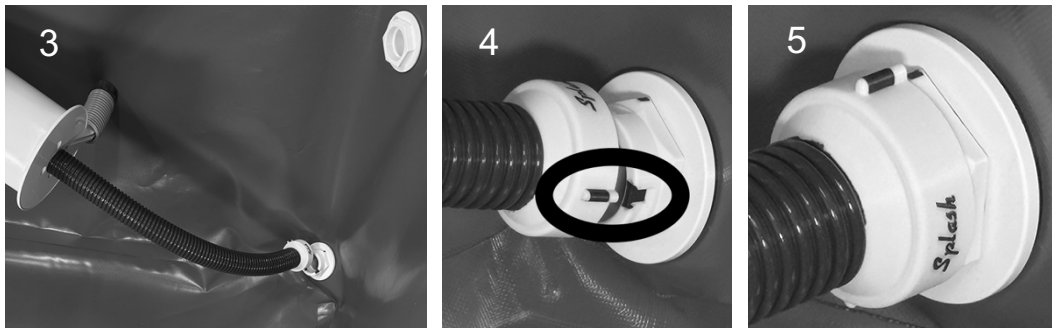

- c) Rotate the entire skimmer clockwise to lock the two parts together. Rotate until you feel it “click” into position. You will feel a resistance and then it snaps into a locked position. The tab on the female part and the line on the nut of the wall adapter should both be in the 12 o’clock position (image 5). Test the connection by twisting the skimmer slightly back in the opposite direction. There should be some resistance. If the tabs on the QC fitting don’t rotate back to the beginning position with the skimmer, the connection is good

- d) Screw the gray skimmer hose back into the top wall fitting and adjust the skimmer housing so that it sits upright in the pool corner.
- e) Place the skimmer basket and weir on the housing and restart your pump and filtration system. Check that your skimmer weir is floating on the water surface properly and adjust the skimmer's orientation as needed.
- f) Warning Label – Affix the Warning Label on the pool liner at the top rail next to the floating skimmer. If the Floating Weir and the internal basket of the skimmer are removed, the resultant strong suction can trap hair or other body parts if they are inserted into the skimmer. Due to this potential hazard, we are recommending that you affix the Warning Label.

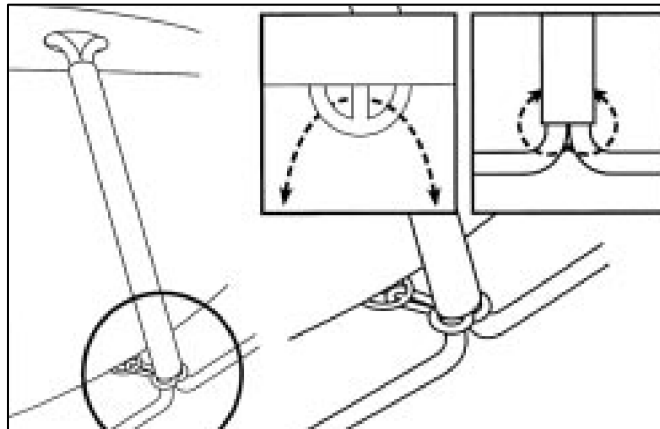

6. Place one Clear Elastic PVC Hose (D) by each upright Tube (C). Insert Connecting Pin (E) in one end of the Hose. Thread the Hose through the base attachment on the outside at the bottom of the pool. (See Figure 6) Thread the Hose between the base Tubes and back around both sides of the Tubes. Connect together with Connecting Pin, making sure the Hose is on the inside of the Tubes closest to the pool. Check to insure all wrinkles are removed. (It may be necessary to pull the Elastic Hose to take out a wrinkle.) After pool has been filled with water, remove the Elastic Hose and save for future use.

**WARNING: Strong suction! Never lay on or insert body parts into skimmer while pump is operating.**

# Installing the Circulation System

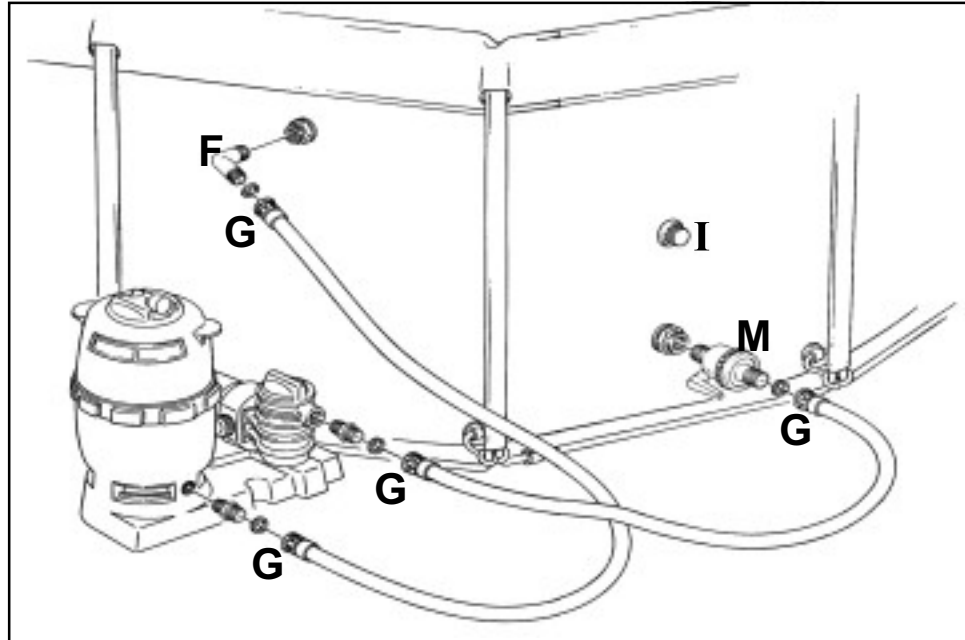

7

Connect the pump and filter (as shown in Figure 7) and fill pool with water.

**WARNING:** The circulation system produces very strong suction. NEVER lay on or insert body parts into the skimmer. Always turn off the pump before working on the skimmer.

# Filling and Starting Your Pool

1. Begin adding water to the pool. When the pool has approximately 1" of water on the bottom, shut the water off. Gently pull on the foot straps to remove any remaining wrinkles. The sides will rise automatically and will be in their proper position when the pool is full. Full position is when water level is approximately 3" from the top of the pool.
2. When the pool is full, plug in the circulation system, making certain the Ball Valve is open (Handle is in-line with hose). You will begin to see water being pulled down into the skimmer. The pump basket area will also fill with water, as seen through the clear lid. At the same time, the pressure gauge on top of the filter will show that water is filling the tank.
3. At this time, "bleed" air from the circulation system by loosening the small threaded plug on the filter lid. You will hear air escaping. Once all the air has escaped, water will follow. When this happens, retighten the plug. The circulation system has now been primed.
4. Assemble the ladder per instructions and place it where desired in the pool. Ladder assembly instructions can be downloaded from [Splashpools.com/manuals](http://Splashpools.com/manuals).
5. Start enjoying your pool.

**WARNING: Strong suction! Never lay on or insert body parts into skimmer while pump is operating.**

# Vacuumping Your Pool

To vacuum your pool, you may either use an automatic cleaner or the traditional manual method. If you choose the manual method, you will need a 1.5" flexible vacuum hose of adequate length, a vinyl liner vacuum head, and a telescopic pole.

Begin by turning the pump and filter off, then place vacuum hose on vacuum head or automatic cleaner. Place vacuum (either auto cleaner or vinyl vacuum head attached to end of telescopic pole) in pool, allowing hose to fill with water. Continue to "feed" hose straight down into water, thus removing air from the hose and replacing it with water. Once you get to the end of the hose, water will come out. Turn the pump and filter on and begin vacuuming.

## Automatic Vacuuming

With the pump turned off, place the Vacuum Adapter Plate ("L") on top of the Floating Skimmer Weir ("H"). Once the pump is turned on, the suction of the pump will hold the plate in place.

Attach vacuum hose into adapter plate hole. Again, pump suction will hold hose in place. Turn on the pump and filter; the pool is now ready to be vacuumed. The automatic vacuum will run on its own. When the pool is clean, turn off the pump and filter, unplug vacuum hose, remove vacuum, and remove adapter plate. This is a good time to empty any debris from the Skimmer Basket ("J"). Finally, turn the pump back on to continue filtering.

**WARNING: Do not attempt to remove or install the vacuum plate while the pump and filter are running. The suction is very powerful; fingers may get pinched between the vacuum plate and the skimmer. DO NOT swim in the pool while the vacuum is running.**

**WARNING: Keep body parts away from vacuum plate when in place and pump and filter are running.**

# Cleaning Filter and Pump Basket

Over time (from a few days to a few weeks, depending on how much the pool is used and environmental conditions), your filter will require cleaning. You might notice a loss of suction when vacuuming or an increase in filter gauge pressure. You should clean the filter when the pressure increases 8-10 lbs. above the filter's initial start-up pressure.

## A. Sand Filter

1. Begin by shutting off the power to the system.
2. Move the lever at top of filter from "filter mode" to "backwash mode".
3. Turn the power to the system back on.
4. Continue to backwash until wastewater becomes clear. Note: It is a good idea to attach a hose to the backwash outlet of the filter. Run the hose to an area where the water will drain away. Also, be sure the water level remains high enough so as not to lose the prime.
5. When wastewater is clear, shut off power to the system.
6. Turn lever back to the "filter mode" setting.
7. Turn the pump and filter back on.

## B. Cartridge Filter

1. Begin by shutting off the power to the system.
2. Close the Ball Valve.
3. Screw a Threaded Plug (found in separate plastic bag) into Return Wall Fitting from the inside of the pool.
4. Open Air Relief Valve.
5. Remove the lid from the Filter Canister.
6. Lift out the Cartridge Filter and clean with a garden hose.
7. Clean Filter Canister by removing Drain Plug at base of filter. Replace plug.
8. Replace Filter Element and reattach lid.

## C. Pump Basket

1. Remove pump lid and clean pump basket. Replace lid.
2. Open Ball Valve, remove Threaded Plug from Return Wall Fitting, and close Air Relief Valve.
3. Turn the power to the system back on.

**WARNING: Pump must be shut off when cleaning**

# Winterizing your Pool

To help guide you in the winterizing process of your Pool, instructions are as follows:

- 1.The use of winterization chemicals will greatly improve the condition of your water when opening the pool in the spring.
- 2.Disconnect the Skimmer and remove it and all hoses from inside the pool. The Skimmer Wall Fitting will need to be plugged from inside the pool, and the Slice/Ball Valve should be opened to allow it to drain. (The valve can be removed but must be free of water for the winter.)
- 3.Drain the water below the Return Fitting, remove the Directional Fitting and do not plug the Wall Fitting. This will help to maintain the low water throughout the winter.
- 4.All Hoses which connect the pump and filter to the pool should be removed at this time. Properly store the Pump, Filter and Hoses for use next season.
- 5.Place pillows in the pool and secure to sides, then apply winter Cover (available as an accessory).
6. Damage to the pool from ice is not covered by the warranty. Some areas may dictate additional precautions.

Note: If your area does not experience freezing temperatures, disregard items 2-6.

**CAUTION: Failure to lower water level could result in ice damage to your pool.**

**STRUCTURAL PARTS PACKAGING LIST**

| <b>SUPER POOL ROUND SIZES</b> | <b>POM4M</b> | <b>BOX4B</b> | <b>LADDER</b> |
|-------------------------------|--------------|--------------|---------------|
| 16'                           | 4            | 1            | 1             |
| 20'                           | 5            | 1            | 1             |
| 24'                           | 6            | 1            | 1             |

**DEFINITION OF PARTS:**

**A** – UNCOATED TOP STRUCTURE **B** – WHITE POWDER COATED BOTTOM STRUCTURE **C** – UPRIGHT STRUCTURE  
**D** – CLEAR ELASTIC PVC **E** – CONNECTING PIN

**POM4M**

COMPLETE STRUCTURE  
 SECTIONS FOR ROUND POOLS  
 EACH CONTAIN  
 4 - PART A  
 4 - PART B  
 4 - PART C  
 1 BAG - PART D & E

**BOX4B**

SKIMMER/VAC HEAD  
 2 - THREADED NIPPLES  
 1 - 9' HOSE  
 1- 12' HOSE  
 2 - WALL FITTINGS  
 1- 90° ELBOW  
 1-SKIMMER HOLD DOWN  
 1-BALL VALVE  
 1 - EYEBALL/DIRECTIONAL  
 1 - PATCH KIT (2 PATCHES)  
 2 - WINTERIZATION PLUGS  
 INSTALLATION USB